

**ENCODERS INCREMENTALES DIAMETRO 40mm**

Certificados de Calidad								
<b>TIPO</b>	SIO 40	SIOM 40	SI1 40	SI1 40A	SI1 40U	SI2 40	SI4 40	SIB 40
<b>DIAMETRO</b>	diam. 40 mm	diam. 40 mm	diam. 40 mm	diam. 40 mm	diam. 40 mm	diam. 40 mm	diam. 40 mm	diam. 40 mm
<b>FORMATO</b>	FLANGE	SCREW	SERVO	SERVO		SCREW	SCREW	SCREW
<b>DIAMETRO FLECHA</b>	4 - 6 mm	4 - 6 mm	4 - 6 mm	4 - 6 mm	4 - 6 mm	4 - 6 mm	4 - 6 mm	4 - 6 mm
<b>MAXIMO DE PULSOS</b>	2500	2500	2500	2500	2500	2500	2500	2500
<b>ELECTRONICA</b>	standar	standar	colector abierto	colector abierto	colector abierto	push pull	push pull	line driver
<b>CONEXION</b>	cable	cable/conector	cable/conector	cable/conector	cable/conector	cable/conector	cable/conector	cable/conector
<b>TIPO DE CONECTOR</b>	-	VA-MP3A	VA-MP3A	VA+MP3A	VA+MP3A	VA+MP3A	VA+MP3A	VA+MP3A

**ENCODERS INCREMENTALES DIAMETRO 58 mm**

Certificados de Calidad								
<b>TIPO</b>	SIO 58	SI1 58	SI2 58	SI2 58ET	SI2 58H	SI 58AU	SIHE 58	SIG 58
<b>DIAMETRO</b>	diam. 58 mm	diam. 58 mm	diam. 58 mm	diam. 58 mm	diam. 58 mm	diam. 58 mm	diam. 58 mm	diam. 58 mm
<b>FORMATO</b>	FLANGE	SERVO	SCREW	SCREW	SCREW	CONT SHAFT	SCREW	SCREW
<b>DIAMETRO FLECHA</b>	6-8-9.52-10 mm	6-8-9.52-10 mm	6-8-9.52-10 mm	6-8-9.52-10 mm	6-8-9.52-10 mm	6 mm	6-8-9.52-10 mm	6-8-9.52-10 mm
<b>MAXIMO DE PULSOS</b>	10 000	10 000	10 000	10 000	10 000	10 000	10 000	10 000
<b>ELECTRONICA</b>	standar	standar	colector abierto	colector abierto	colector abierto	push pull	push pull	line driver
<b>CONEXION</b>	cable/conector	cable/conector	cable/conector	cable/conector	cable/conector	cable	cable/conector	cable/conector
<b>TIPO DE CONECTOR</b>	J. - J1. - D. - D1. - M. - M1. - CN. - V. - MP3				J. - J1. - D. - D1. - M. - M1. - CN.			

**COMO ORDENAR ENCODER INCREMENTAL**

**TIPO**  
**S10 63**  
**BZ 2000 SN 2 MA 10 X**

**EJECUCIÓN ESPECIAL**  
**IP67 = SS**      **IP65 = S**

**FLECHA**  
**4** = Ø 4 mm      **10** = Ø 10 mm  
**6** = Ø 6 mm      **12** = Ø 10 mm  
**8** = Ø 8 mm      **14** = Ø 14 mm  
**9** = Ø 9.52 mm

**FORMATO DE CONEXIÓN**  
**M6.** = Conector de 6 polos  
**M.** = Conector de 7 polos  
**M1.** = Conector de 10 polos  
**V.** = Conector tipo DB9  
**D.** = Conector tipo DDK de 7 polos  
**A** = Axial  
**J.** = Conector JAE de 7 polos  
**D1.** = Conector DDK de 10 polos  
**MPL.** = Conector tipo electroválvula  
**MP3A.** = Conectores tipo electroválvula  
**CN.** = Conectores de 4 polos  
**H.** = Conector macho 12 polos sin anillo  
**HM.** = Conector macho 12 polos con anillo  
**HP.** = Conector macho tipo Panel  
**C.** = con cable 3 mts.







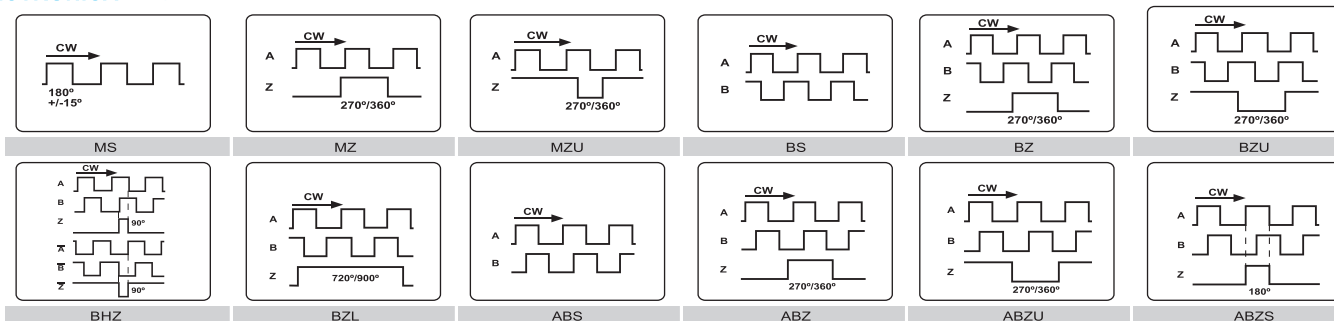

**RESOLUCIÓN**  
**1-10000**

**ELECTRÓNICA**  
**SN - SP - OCN - OCP - EA - EAP - CL - CD - E2A - E2AP**







**ALIMENTACIÓN**  
**1** = 5 Vdc      **3** = 8-15 Vdc  
**2** = 10-30 Vdc      **4** = 5-12 Vdc

**ELECTRÓNICA DE SALIDA**

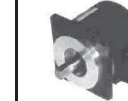
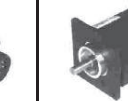

								
SIE 40	SIXE 40	SILO 40	SIG 40	SIC 40	SIAP 40	SIV 40	SIV 40L	SIRE 40
diam. 40 mm	diam. 40 mm	diam. 40 mm	diam. 40 mm	diam. 40 mm	diam. 40 mm	diam. 40 mm	diam. 40 mm	diam. 40 mm
SCREW	SCREW	SCREW	FLANGE	HOLLOW SHAFT	CONT. HOLLOW SHAFT	M18	M18	SCREW
4 - 6 mm	4 - 6 mm	4 - 6 mm	4 - 6 mm	6 mm MAX	6 mm MAX	4 - 6 mm	4 - 6 mm	4 - 6 mm
2500	2500	2500	2500	2500	2500	2500	2500	2500
standar			colector abierto			push pull		line driver
cable/conector	cable/conector	cable/conector	cable/conector	cable/conector	cable	cable / conector	cable/conector	cable/conector
VA+MP3A	VA+MP3A	VA+MP3A	VA+MP3A	VA+MP3A	-	VA+MP3A	VA+MP3A	VA+MP3A

ENCODERS INCREMENTALES DIAMETRO 63 mm

							
SIO 63LE	SIO 63	SIO B63	SIO5 63	SI1 63	SI2 63	SI8 63	SIC 63
diam. 63 mm	diam. 63 mm	diam. 63 mm	diam. 63 mm	diam. 63 mm	diam. 63 mm	diam. 63 mm	diam. 63 mm
FLANGE	FLANGE	-	-	SERVO	VITE-SCREW	-	HOLLOW SHAFT
6-8-9.52-10 mm	6-8-9.52-10 mm	6-8-9.52-10 mm	6-8-9.52-10 mm	6-8-9.52-10 mm	6-8-9.52-10 mm	10 mm	15 mm MAX
4000	10 000	10 000	10 000	10 000	10 000	10 000	10 000
4-20 mA 0-10 VAC	colector abierto	colector abierto	colector abierto	push pull	push pull	line driver	line driver
cable	cable/conector	cable/conector	cable/conector	cable/conector	cable/conector	cable/conector	cable/conector
J. - J1. - D. - D1. - M. - M1. - CN. - V. - MP3							

ELECTRÓNICA DE SALIDA

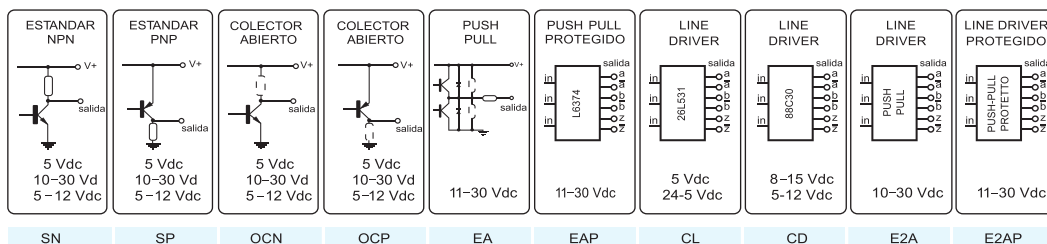

CONECTORES

SN - SP - OCN - EA-EAP  
 CD - CL - E2A - E2AP  
**COMPATIBILIDAD CONECTORES**  
 M6A/M6R MA/MR VA/VR DA/DR CA/C1R JA/JR  
 MPM/MP3A (A) CNA/CNR (A+B) CA/CR

CONEXIONES

